

# EchoTile Ascent Installation Guide

*Note: Please read the entire Installation Guide before application.*

The installation guide is intended to provide installers with helpful information regarding EchoTile Ascent prior to installing the material. Kirei accepts no responsibility for installation actions taken or not taken. This installation guide is not intended to be an in-depth guide; installers' knowledge as experienced tradesman needs to be applied.

This installation guide serves only as a recommendation for installing and handling EchoTile Ascent. If you have questions about application or techniques, contact Kirei at [www.kireiusa.com](http://www.kireiusa.com) or 619.236.9924.

## ECHOPANEL SPECIFICATIONS

### What is EchoTile Ascent?

EchoTile Ascent is made from EchoPanel®, a decorative surface material offering acoustic performance with a felt-like finish. It is made from 100% PET thermally stable plastic which, contains at least 60% post-consumer content. EchoPanel is also recyclable in the PET waste stream. Please consult the EchoTile Ascent spec sheet for material specifications.

### Fire Rating

ASTM E84 Class A

### Low VOC Material

EchoPanel is considered a low-VOC emitting material making it a healthy building option for interior finishes. EchoTile Ascent is ASTM D5116 Rate: 0.008 mg/m<sup>2</sup>/hr (7 days).

### Handling and Storage

Keep it clean! EchoPanel is an absorbent material and traps dirt, grime and debris just as well as it does sound. White glove handling is recommended for prep, processing and installation. Kirei is not responsible for mishandling on the job site.

Keep it flat! If cutting, drilling or mounting hardware on site, make sure that EchoTile Ascent is evenly supported on a flat, clean surface. Improperly handled material can crease.

Storage areas should be clean, dry, cool, and well ventilated.

# EchoTile Ascent Installation Guide

## Handling and Storage (Cont.)

All EchoTile Ascent products are inspected prior to shipment. Kirei is not responsible for damage in shipment or in storage; customers should carefully inspect all items at time of delivery and note any obvious damage on the delivery receipt. For the customer's protection subsequently discovered concealed damage must be reported immediately to the carrier. Claims to Kirei will not be considered if the sheet has been worked by the customer or others. No claims for labor charges will be allowed in any circumstances.

To handle and store EchoTile Ascent properly, follow these guidelines:

- Carefully inspect all material at time of delivery and note any obvious damage on the delivery receipt.
- Keep EchoTile Ascent as clean as possible during storage. EchoTile Ascent should be kept free from grease, wax, dust, and chips that could leave impression.
- Store EchoTile Ascent indoors, in a dry, cool, well-ventilated area.
- Avoid exposure to heat 150°F (65°C) or greater.
- Keep table tops clean to avoid scratching.
- Inspect for defects, then recover for protection during fabrication.
- Wear clean white gloves when handling EchoTile Ascent.
- Do NOT store EchoTile Ascent near radiators, steam pipes, or in direct sunlight.

## Cleaning and Care

Remove dust and dirt by dusting, vacuuming, or with a soft cloth or sponge and a solution of carpet or upholstery shampoo. Always use a soft, damp cloth and blot dry. Spot cleaner such as ZEP Commercial Instant Spot Remover has been used with success for some light soil situations. No guarantee is given for cleaning results with this product.

## Contents of One EchoTile Ascent Box

- (6) Ascent Tiles
- (4) Clip A
- (8) Clip B
- (4) Clip C
- *16 total clips, which are appropriate for a 3 x 2 tile configuration*

# EchoTile Ascent Installation Guide

## Installation

1. Mark out the desired clip pattern. The pattern shown is based on a 35.5 in. x 19.6 in. grid. *Please note, this pattern can also be rotated 90 degrees for a landscape layout.*

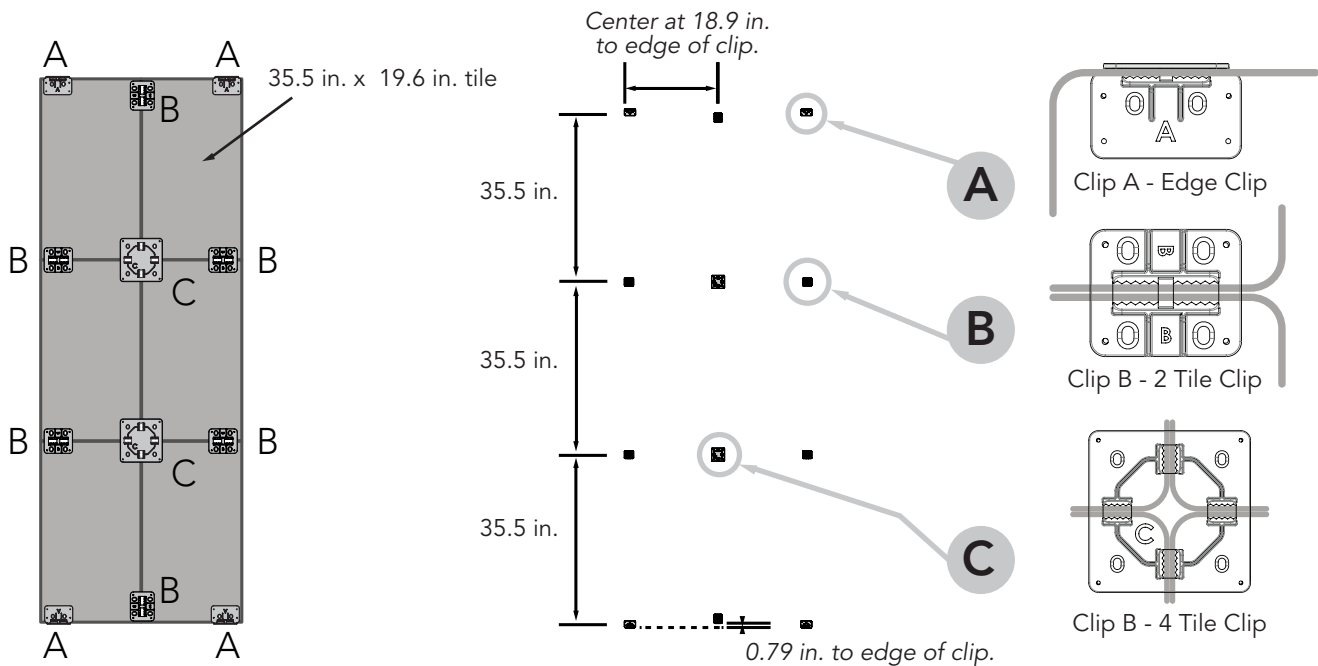

2. Choose either nails or screws to suit wall construction. You may want to use double sided tape to temporarily hold the clips while installing them. If using nails, it is critical that they are inserted at an angle.

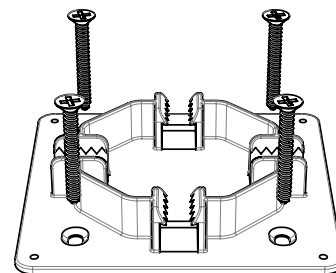
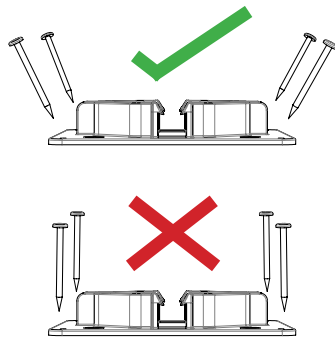
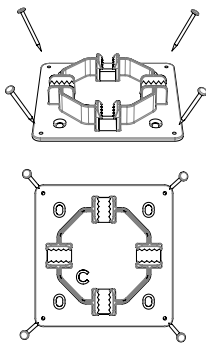

Screws may require additional fixing accessories like wall plugs for masonry.

# EchoTile Ascent Installation Guide

- When all the clips are fixed you will have a grid of clips ready to install the tiles.
- Align tiles in clips before pushing them into position. *Please note, Tiles are difficult to remove once installed.*

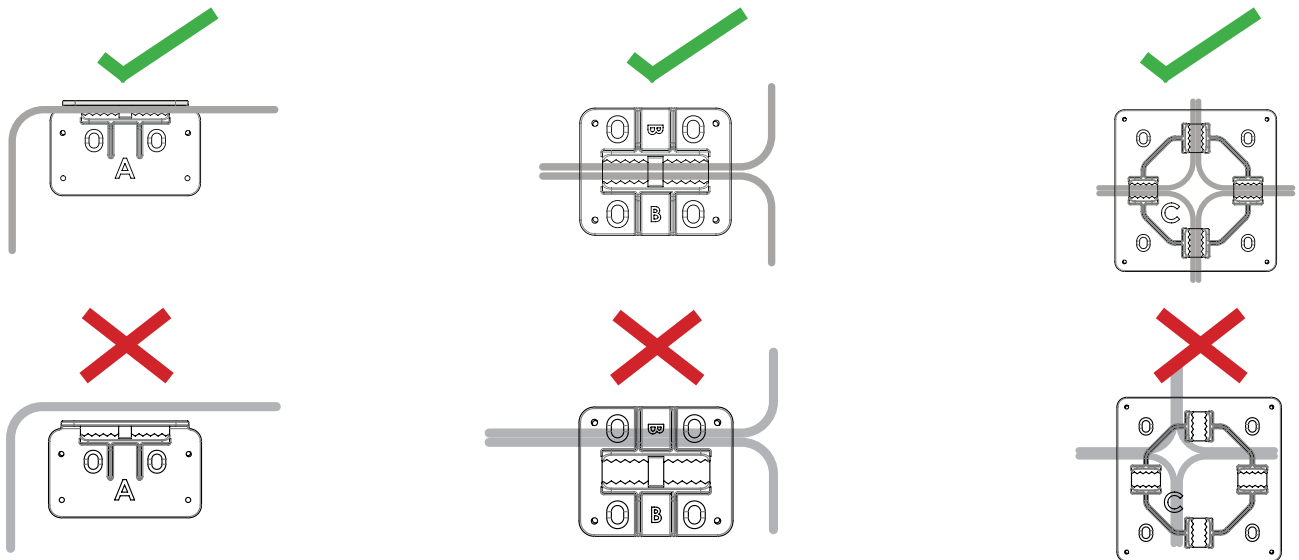

- The clips supplied are appropriate for the installation of 6 tiles arranged in a 3 x 2 grid. The arrangement as shown, can be achieved with 2 boxes of 12 tiles. Other layouts will require extra clips. Additional clips are available in packs of 10 of A, B, C, or 16 mixed clips.

All tiles need a clip at each corner. Use Edge Clip (A) for any perimeter corner (as shown). Use 2 Tile Clip (B) where tiles meet (as shown). Use 4 Tile Clip (C) where 4 tiles intersect (as shown).

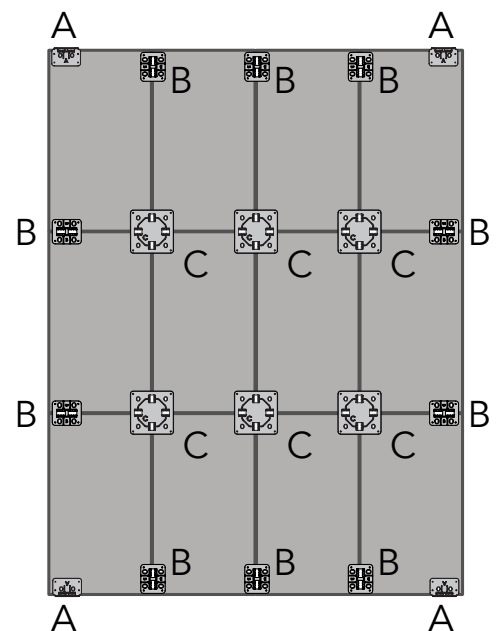

# EchoTile Ascent Installation Guide

## Important Notes:

### Infill

The infill is an optional add-on. This material is made from 100% PET (at least 60% recycled) and measures 35"x19"x1". To install, place the infill inside the Ascent tile before clipping the tile to the wall.

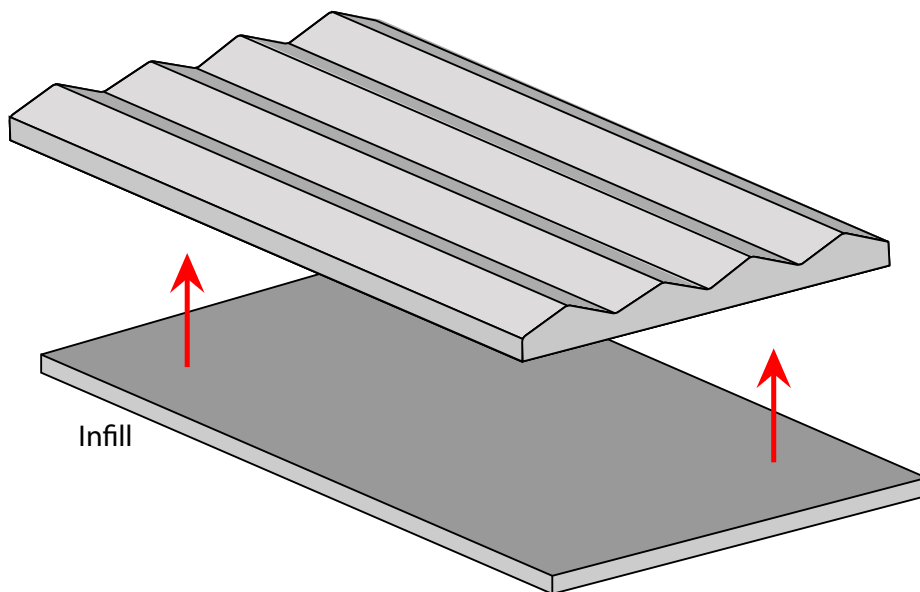

## Work Safety

In the interest of work safety, it is recommended that people working with EchoTile Ascent wear the appropriate safety equipment. Although the product emits zero off-gases, masks and gloves should be worn to ensure the maximum possible safety precautions. For an SDS form, please contact Kirei at [info@kireiusa.com](mailto:info@kireiusa.com) or 619-236-9924.

## Final Note

Kirei will not be responsible for any cutting or mounting not performed by Kirei staff.

**For any other questions or concerns, please contact Kirei.**