



kirei

I BAFFLE

Acoustic Baffles

I Baffle is an acoustically and visually enhanced extension of Kirei's Simple Baffle. The I Baffle is composed of two 12mm panels attached back-to-back, providing increased acoustic control with an added element of color customization - pick two similar or different panel colors to create new visual effects. Hang I Baffles in regular rows, random groupings, or with other baffle systems to create beautiful architectural design solutions. Custom configurations available.

Product shown: I Baffles in Colors 442 (Grey) & 487 (Blush)

Specs

Style	Standard (LxH)	Width	Weight	LF/Unit
40" Baffle	40 in. x 11.5 in.	0.94 in.	3.5 lbs	3.3
48" Baffle	48 in. x 11.5 in.	0.94 in.	4 lbs	4
72" Baffle	72 in. x 11.5 in.	0.94 in.	6 lbs	6
96" Baffle	96 in. x 11.5 in.	0.94 in.	8 lbs	8

All specs refer to singular products and not multiples unless specified. Due to the nature of the material, cutting and fabrication process, minor dimensional variances may occur.

Designer	Kirei
Baffle Thickness	24mm EchoPanel®
Material	EchoPanel®, a registered trademark of Woven Image®, is PET felt made with at least 60% post-consumer content.
Fire Rating	ASTM E84 Class A
Custom Options	Available upon request
Lead Time	*4-6 weeks (1-100 baffles) *6-8 weeks (150-200 baffles) <i>For larger quantities, lead times determined per order</i>
VOC Emissions	CDPH (CA 01350) Compliant TVOC: <0.5 mg/m3 Ecospecifier GreenTag Compliant TVOC: 0.015 mg/m2/hr (ASTM D5116)

*Actual lead times are determined when the project goes into production and can change based on production schedule and all quantities, color and thicknesses being in stock at time of order. See [Kirei's Product Lead Time Disclosure](#) for more information.



Acoustic Data

Sound Absorption

Frequency	250Hz	500Hz	800Hz	1000Hz	2000Hz	4000Hz	Average
m ² /Object	3.40	4.21	4.71	5.08	5.35	2.23	3.66

Acoustic data is measured in Sabins per I Baffle at 12" spacing.

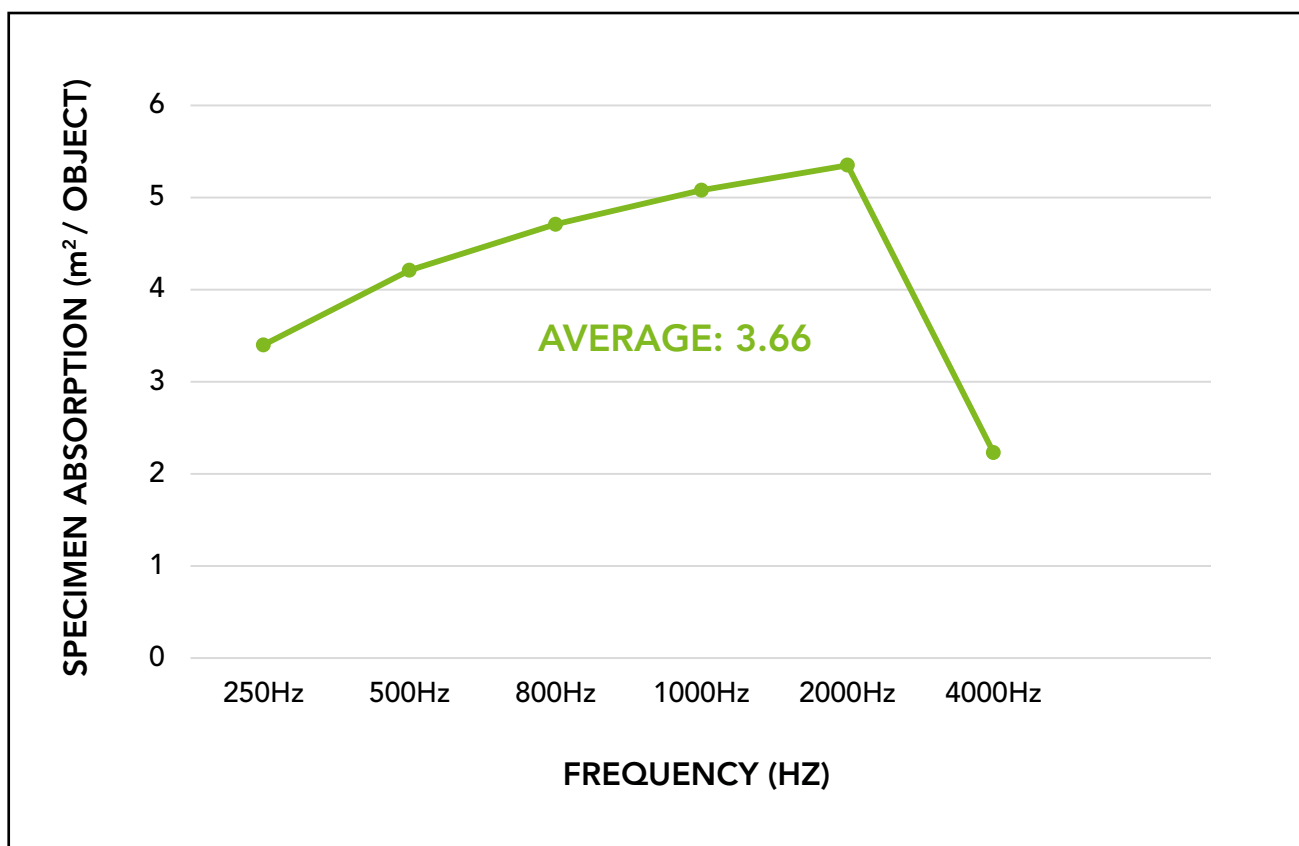

Product Dimensions

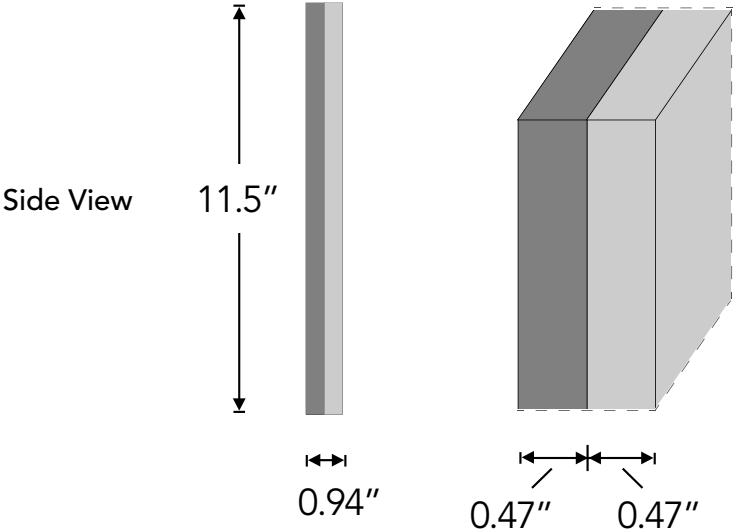
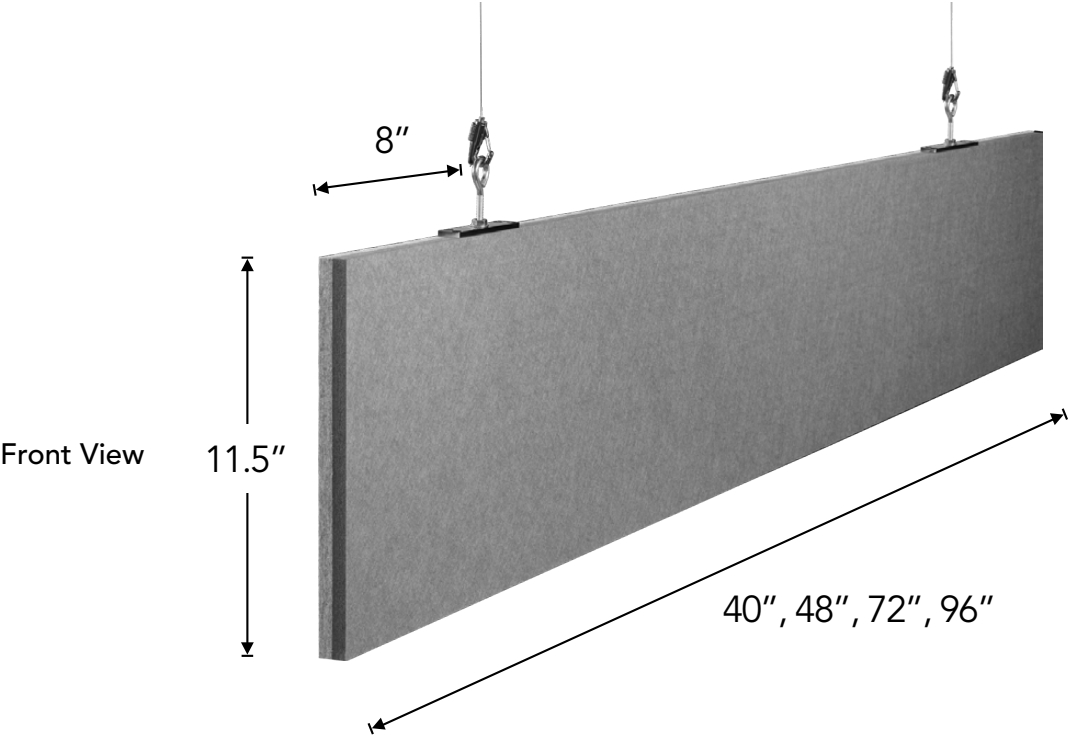

Available Colors



101 Frost



108 Sunshine



124 Ochre



167 Cinnamon



193 Rouge



269 Wine

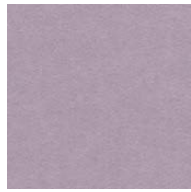

274 Orchid



276 Lavender



295 Mandarin

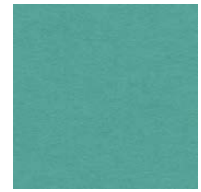

325 Viridian



330 Ivy



338 Jade



349 Vineyard



365 Navy



381 Lime Splice



384 Olive



402 Pebble

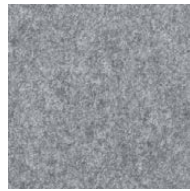

442 Grey

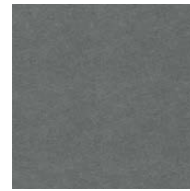

444 Smoke



447 Slate

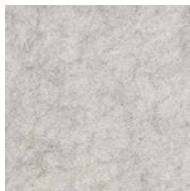

454 Mushroom



468 Vanilla



487 Blush



500 White



542 Black



550 Onyx



551 Duck Egg



576 Magenta



579 Pistachio



580 Sage



633 Pacific



660 Coronet



908 Cream

Installation

I Baffles have two attachment points with a 1/4"-20 female thread and come with your choice of eyebolts or 1/4"-20 male threaded screw hardware. To install I Baffles, attach the specified ceiling mounting hardware and suspension cable/chain/rod/etc. with the appropriate connector at the bottom end. Once the ceiling hardware is installed, attach the connector to the supplied attachment hardware on the I Baffle. For instructions on how to install baffles in a variety of ways, see the [I Baffle Installation Guide](#).

Note: Kirei does not provide ceiling mounting hardware or cable/chain/rod.

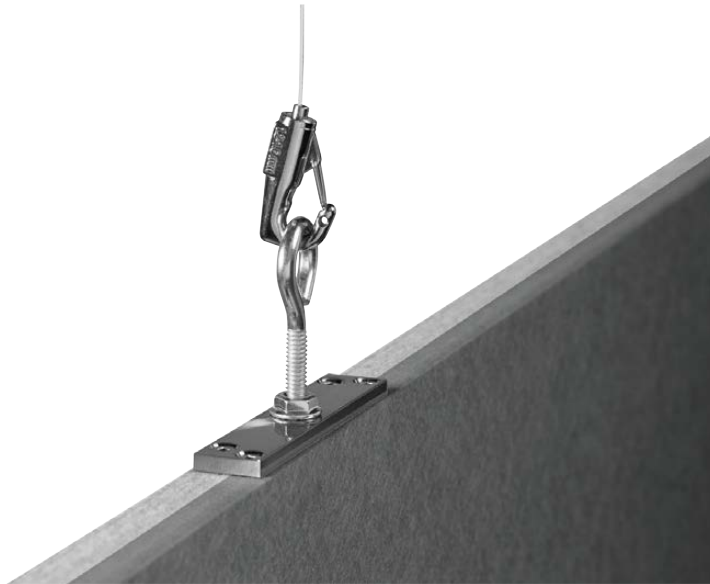

1/4"-20 Male Threaded Screw Mounting Hardware

Custom Printing with Kirei Ink

I Baffles can be custom printed in house with Kirei Ink. We would love to work with you to print your own custom color, pattern, graphic or material. Reach out and our team will be ready to assist!

Please note: Kirei requires written permission from the copyright holder in order to reproduce any copyrighted work. Professional photographs cannot be reproduced without written permission from the photographer.



Product shown: I Baffles in Colors 442 (Grey) & 487 (Blush)



Product shown: I Baffles in Colors 442 (Grey) & 487 (Blush)



Product shown: I Baffles in Color 442 (Grey) & 338 (Jade)

kirei

Learn more and request your free sample:

619.236.9924 | sales@kireiusa.com

kireiusa.com