

# PET PANELS

INSTALLATION GUIDE

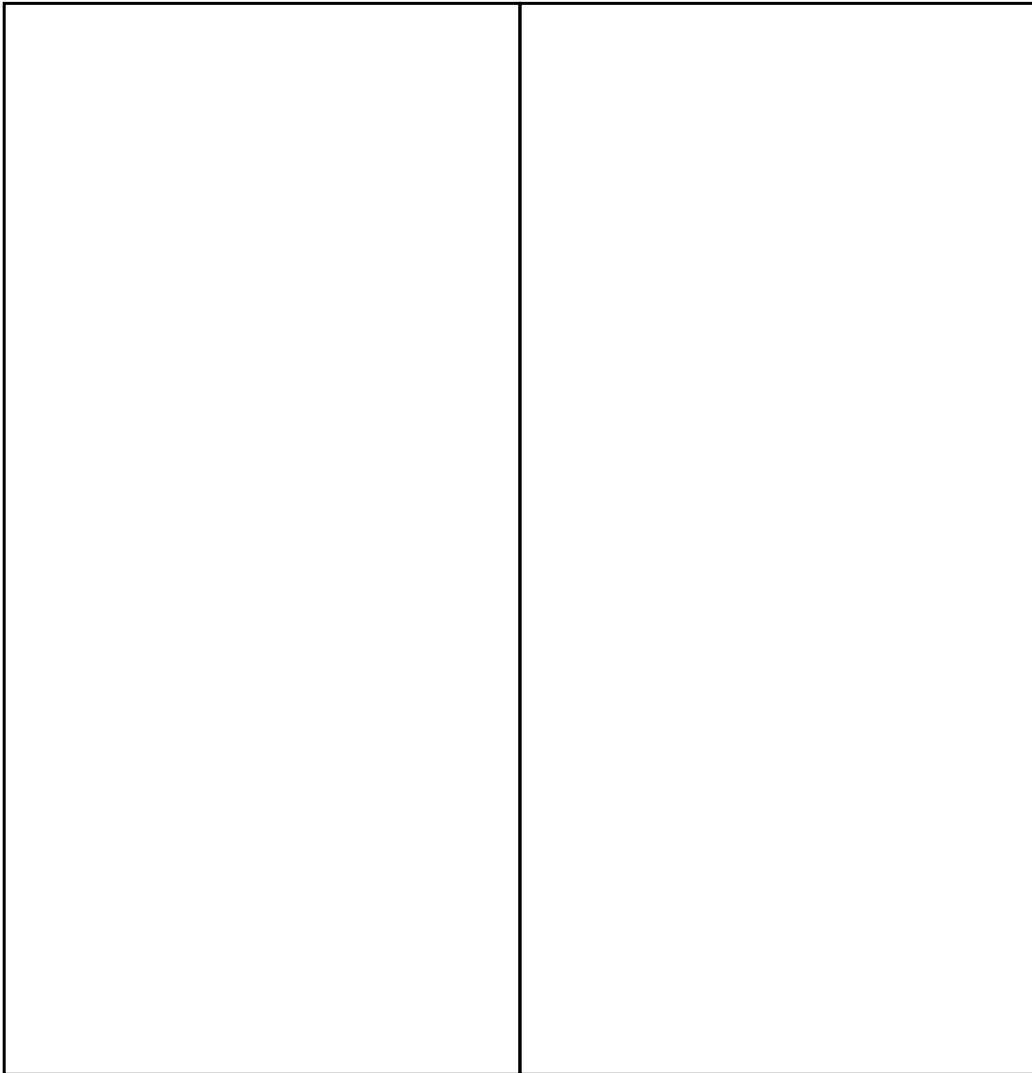

**kirei**

# IMPORTANT INFORMATION

## Installation

Please read the entire Installation Guide prior to application. This installation guide is intended to provide installers with helpful information regarding PET panels prior to installation. Kirei accepts no responsibility for installation actions taken or not taken. This installation guide is not intended to be an in-depth guide; installer's knowledge as an experienced tradesman needs to be applied.

If you have questions about application or techniques, contact Kirei. Kirei will not be responsible for any cutting or mounting not performed by Kirei staff.

## Terms of Trade

All PET panels are inspected prior to shipment. Kirei is not responsible for damage in shipment or in storage; customers should carefully inspect all items at time of delivery and note any obvious damage on the delivery receipt. For the customer's protection, subsequently discovered concealed damage must be reported immediately to the carrier. Claims to Kirei will not be considered if the sheet has been worked on by the customer or others. No claims for labor charges will be allowed in any circumstances.

## Work Safety

In the interest of work safety, it is recommended that people working with PET panels wear the appropriate safety equipment. Although the product emits zero off-gases, masks and gloves should be worn to ensure the maximum possible safety precautions. For an SDS form, please contact Kirei.

## Cleaning

See the [Handling and Cleaning Guide](#) for more information.

## PET Panel Specs

See the [PET Panel Spec Sheet](#) for product details and information.

## Product & Installation Questions

PH: 619.236.9924

Email: [info@kireiusa.com](mailto:info@kireiusa.com)

Web: [kireiusa.com](http://kireiusa.com)

# HANDLING

Carry boxes and panels upright.

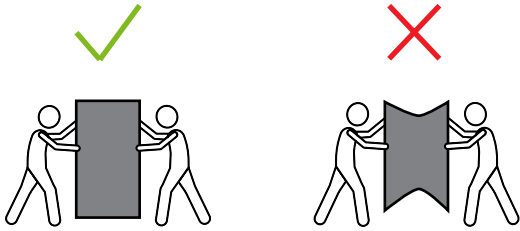

Keep all surfaces clean for storage and fabrication.

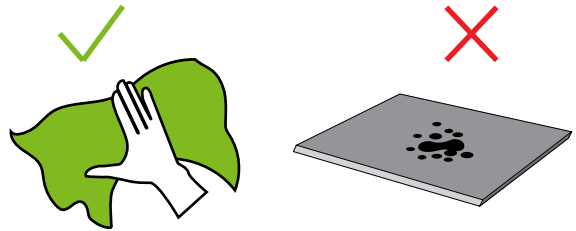

Store boxes and panels flat.

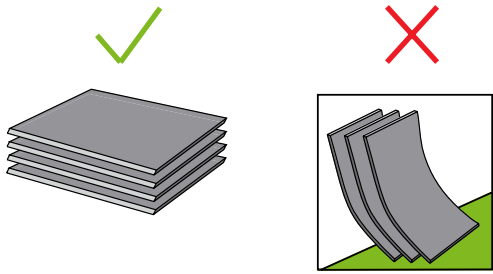

Store in a cool, dry place with no direct sun. Avoid 145 degree temperatures or greater.

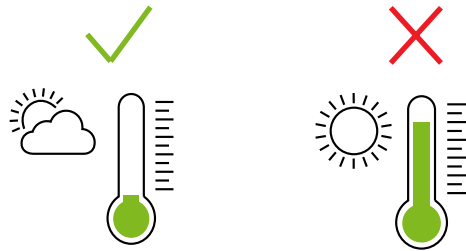

Wear gloves for handling light colors.

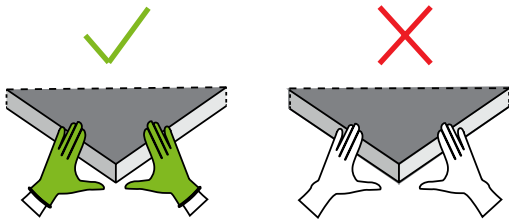

Upon delivery, inspect all goods for order corrections and damage.

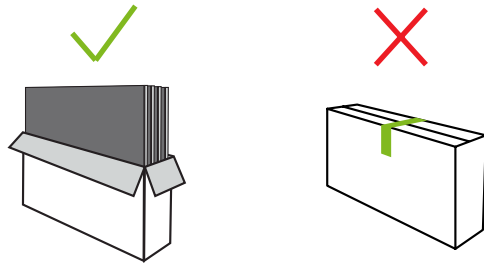

Keep product dry and avoid humidity.

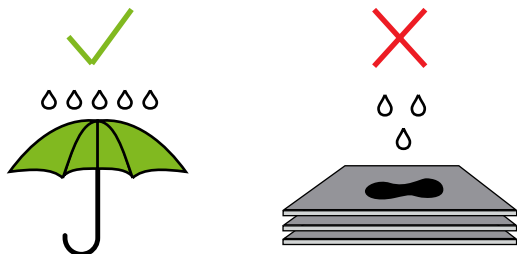

Protect the edges.

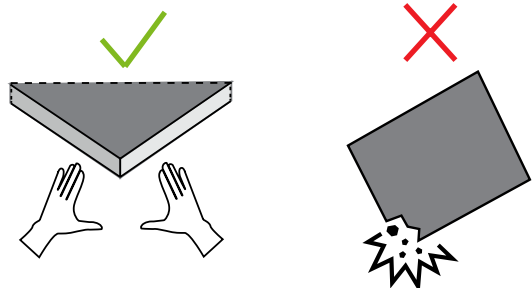

# PRODUCT NOTES

## Cutting

PET panels can be cut to custom size and shape or trimmed to match site conditions. It is highly recommended that a test cut be done on scrap material to ensure acceptable results. Kirei will not take responsibility for any cuts done by anyone other than Kirei approved vendors.

All cutting should be done on a very clean and evenly supported surface. Test cutting should be performed and evaluated well in advance of ordering material. For additional information, please contact Kirei.

If your project requires precision cut or abutted panels, compound angles, radius corners, curves, perforations, miter cuts or vee cuts, we highly recommend CNC knife cutting of panels to ensure clean edges and accurate cuts. Kirei can provide CNC panel cutting services. Please contact Kirei for more information or for a quote.

## Drilling

Standard drills for wood or metal can be used; however, they require slower speeds to produce a clean, non-gummed hole. Optimum bit speed and applied pressure will depend on the hole size and sheet thickness desired. Drill speeds up to 1,750 rpm are best for smaller holes, while speeds as low as 350 rpm can work for larger holes. Tapered "pilot" drills work best for hand pre-drilling smaller holes.

Make sure PET panels are fully supported from beneath with a clean material that will not contaminate the panels while drilling. Be sure not to dimple the panel by pressing too heavily with a drill bit that is not capable of piercing the surface.

Drills used for plastics are suited to working with PET panels; they should have two flutes, a point with an included angle of 60 to 90 degrees, and a lip clearance of 12 to 18 degrees.

Wide, highly polished flutes are desirable since they expel the chips with low friction and thus tend to avoid overheating and consequent gumming. Drills with substantial clearance on the cutting edge of the flutes make smoother holes than those with less clearance. Drills should be backed out often to free chips.

*Note: When drilling be sure to hold or clamp the sheet securely to prevent it from slipping and presenting safety hazard to the operator, but not so hard as to cause indentation.*

### Cutting and Drilling Guidelines

- Wear proper safety equipment.
- Always practice on pieces of scrap material before cutting parts.
- Use sharp, clean blades and bits with a slow, consistent feed rate.
- Hold sheet firmly while cutting to minimize vibration; use just enough clamp pressure to prevent vibration but not so much as to cause indentation.
- Feed against the rotation of the blade or tool.
- Don't cut or drill with a dull blade, cutter, or bit.
- If pre-drilling by hand, a tapered pilot bit works the best.
- Don't apply excessive clamping pressure.
- Don't use a blade with side-set teeth.
- Don't remove safety guards from equipment.

# PRODUCT NOTES

## Sawing

PET panels may be cut with a variety of saw types, depending on the type and precision of cut required. Tool speeds and angle of cut should be such that the panels do not melt from frictional heat. In general, the highest speed at which overheating of the tool or sheet does not occur will give best results.

A method of reducing heat is by making several passes while cutting or trimming the sheet rather than trimming "deep" through the sheet. It is important to keep cutting tools sharp at all times. For best results use fine-toothed blades such as those for high pressure laminate or plastics typically work best. High-speed or carbide-tipped tools are efficient for long runs and provide accuracy and uniformity of finish. Bring the blade to full speed before starting the cut. Secure the sheet during cutting operations to minimize vibration.

*Note: When sawing, please ensure that all saws, equipment and blades are free from any contaminants including sawdust and grease which may soil the panels.*

- **Track Saw**  
A recommended tool for precision straight cuts on site is a full length track saw such as the Festool TS 55 with 54 tooth Laminate Blade. Test cut prior to cutting finished goods.
- **Circular Saw**  
PET panels may be cut using a circular saw and a suitable full length guide. Select a new, fine tooth blade for cutting plastics or high pressure laminate. Test cut prior to cutting finished goods.
- **Band Saw**  
Band saws with fine tooth blades are best suited for detailed cuts. Completely clean saw and blade of all contaminants prior to use with PET panels. Test cut prior to cutting finished goods.

## Manual Trimming

PET panels can be readily cut or trimmed with a utility knife. Use a new, clean blade and change blade as needed to maintain high quality cuts. Use a straight edge as a guide. Hold the knife as vertically as possible and make long, continuous cuts in the same direction using a straightedge as a guide. Typically 3-4 passes are needed to safely cut through 12mm PET panels. Hand Trimming is not recommended for abutting panels.

## CNC

CNC cutting with a drag knife or oscillating knife is the best way to ensure cutting of precision shapes, edges and dimensions. Kirei can provide custom CNC cutting. Please request information or a quote when ordering PET panels. Kirei will not take responsibility for any cuts done by other than Kirei approved vendors

## Routing

Cutting or milling with a spinning router bit is not recommended due to frictional heat which can cause tearing and melting.

# PRODUCT NOTES

## **Trimming/Abutting Panels**

PET panels are sold with up to +/- 10mm dimensional tolerance and may have an irregular factory-supplied edge. Trimming will be necessary to remove factory supplied edges if a perfect square panel and panel edge is required. This should be noted particularly when butt joining panels together. It is recommended that edge trimming be done with a track saw or using a CNC knife.

## **Directionality of Material**

PET panels are produced from pre-colored PET fibers and has very consistent color match across production runs. During the manufacturing of PET panels, the PET fibers are layered with a slight directionality or grain. Due to this process, some fiber directionality and slight variation may be visible on the face of the material. The directionality of the grain is most evident in the heathered colorways, such as colors #442 and #542. In all solid colors, this grain may become more visible in certain installations based on panel orientation, light reflectivity and type of lighting.

If PET panels are cut into tiles or smaller panel sections, these pieces may have a directional surface finish. Kirei recommends the tiles or panel sections be cut with the fibers facing in one direction and are installed with desired fiber orientation to ensure best color matching.

Prior to installation, Kirei recommends visual inspection of the material oriented in the same arrangement as they will be installed for best fiber match results.

## **Span Distance**

PET panels, like most sheet panel products, has a tendency to flex over large spans. Although there is no set formula for acceptable span distance, it is reasonable to expect that placing attachment hardware between 6 to 12 inch spans both vertically and horizontally would cause the panel to remain rigid in most circumstances.

## **Hanging PET Panels**

PET panels can be suspended using a variety of hardware. Kirei can supply a range of hardware to hang panels in many situations.

## **Curves, Folds and Thermoforming**

Being 100% PET, PET panels have the characteristics of most plastic type products when thermoforming. PET panels is an incredibly versatile material and can be readily fabricated into 3D geometric shapes via folds, kerf cut bends or interlocking panels. Please reach out to our team to discuss your project, we do custom daily!

Heat can be applied to the panel while it is held in-form and then allowed to set. Specialist thermoformers should be consulted to work with PET panels. These businesses would typically work in shaping plastics and foams.

# DIMENSIONS

Panel Front View

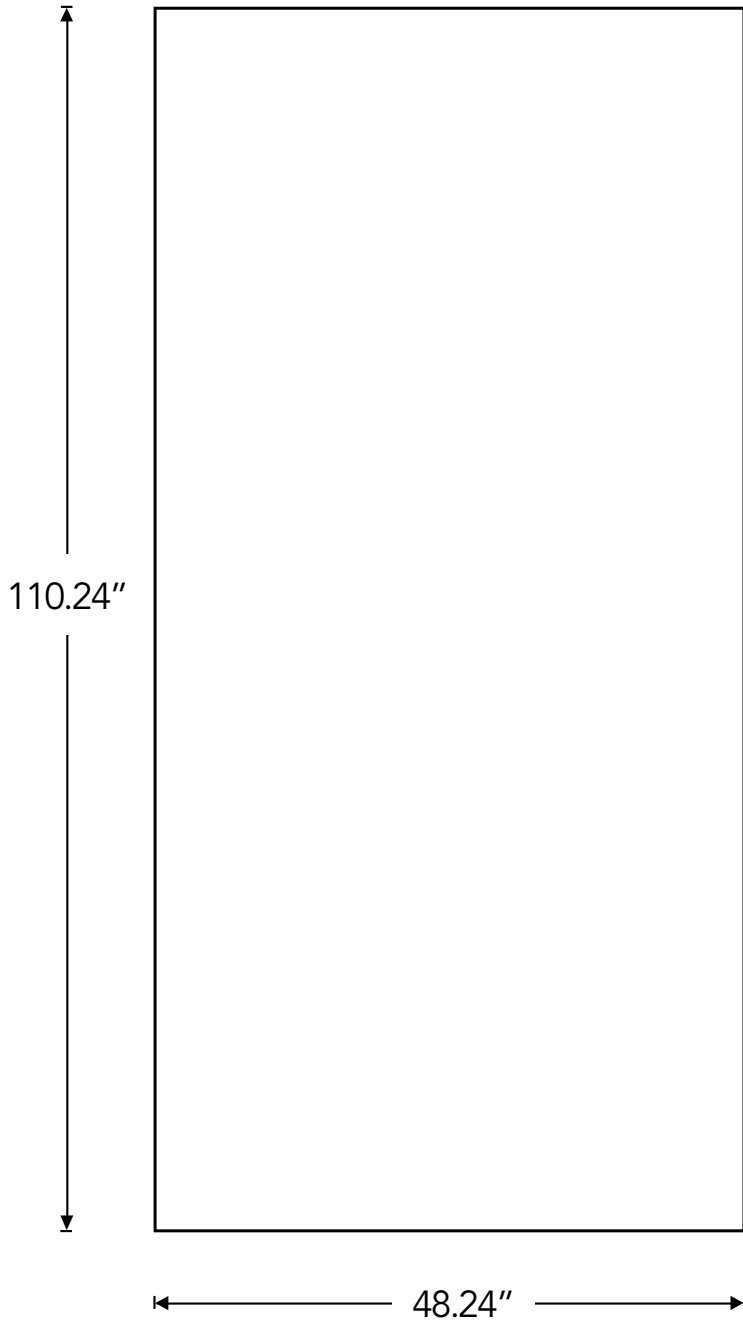

Panel Side View

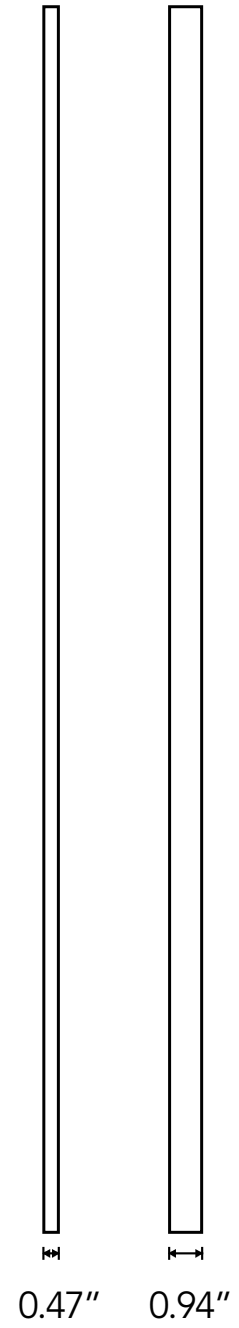

## TOOLS MAY BE NEEDED



Level

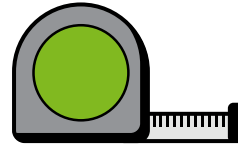

Tape Measure



Adhesive



Screw Driver

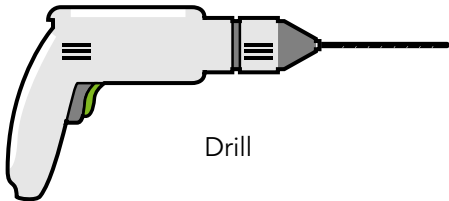

Drill



Saw

Not all tools are needed for installation, but depending on install choice, could be used.

## ITEMS INCLUDED



PET Panels



# DIRECT MOUNT INSTALLATION

PET panels can be adhered to walls and ceiling using adhesive. Direct mount is the recommended installation method for adhesives.

The recommended adhesives to use with PET panels include Loctite PowerGrab Construction Adhesive, Loctite PL 3X Premium Construction Adhesive, Liquid Nails LN903 Heavy-Duty Construction Adhesive, AFM Safecoat Almighty Adhesive (solvent free solution), and ChemLink BuildSecure Construction Adhesive (solvent free solution). **Do not use PVA Glue for an adhesive for PET panels.**

- 1** Clean and prepare surface per adhesive guidelines, then spread adhesive evenly on panel back leaving a 2" space at edges.

- 2** Adhere to wall surface per layout and maintain even pressure per adhesive manufacturer time and instructions. Clean off any excess adhesive.

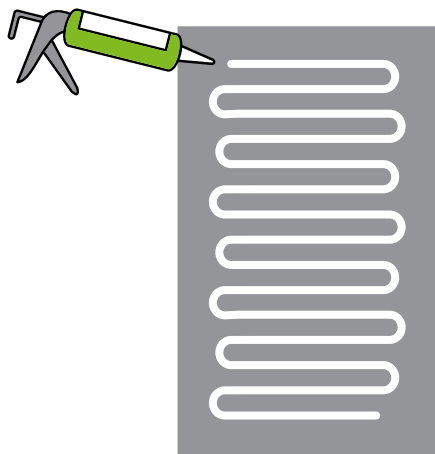

# FURRING STRIPS INSTALLATION

For best acoustic results, furring strips may be used to provide an air gap behind panels. These strips can be made from wood or other battens, standoffs, or by cutting additional panel strips.

Standoffs can also be used and provide a more decorative install method to increase acoustic performance. We recommend 1.25" diameter or greater and up to 2" depth for best results. Standoffs should be evenly spaced to properly support the panel and brace against any expected impact.

- 1** Clean and prepare surface per adhesive guidelines, then spread adhesive evenly on 3" furring strips (recommended width).

- 2** Place strips every 6"-18" along the panel depending on expected potential impact.

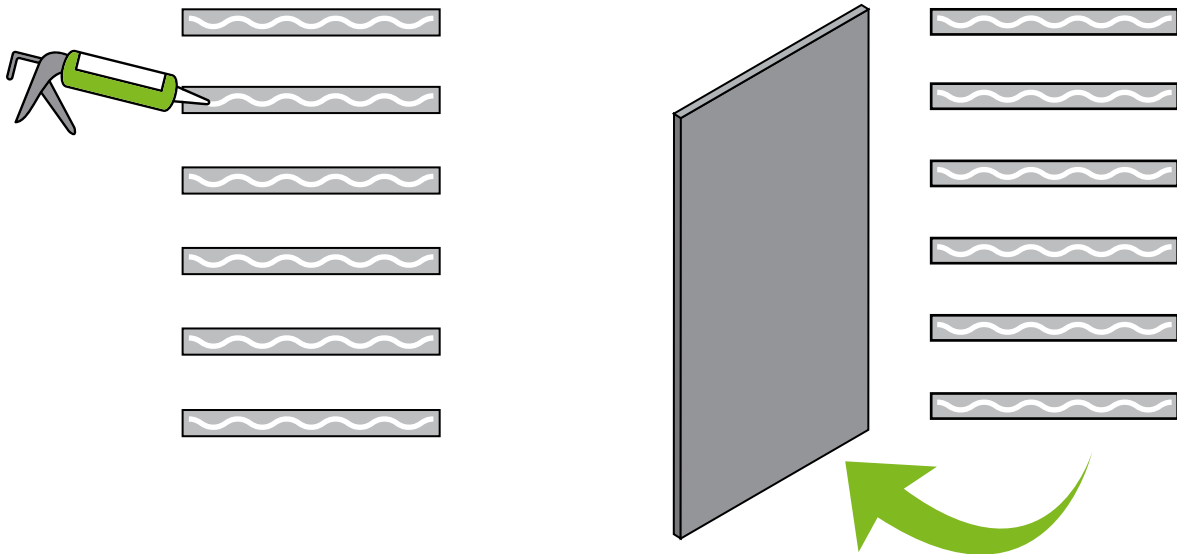

## FURRING STRIPS INSTALLATION

3

Spread adhesive on attached furring strips and adhere to wall surface per layout. Brace per adhesive instructions and maintain even pressure per adhesive manufacturer time and instructions. Clean off any excess adhesive.

*Edges may be covered with additional panels strips or other surface for a clean edge.*

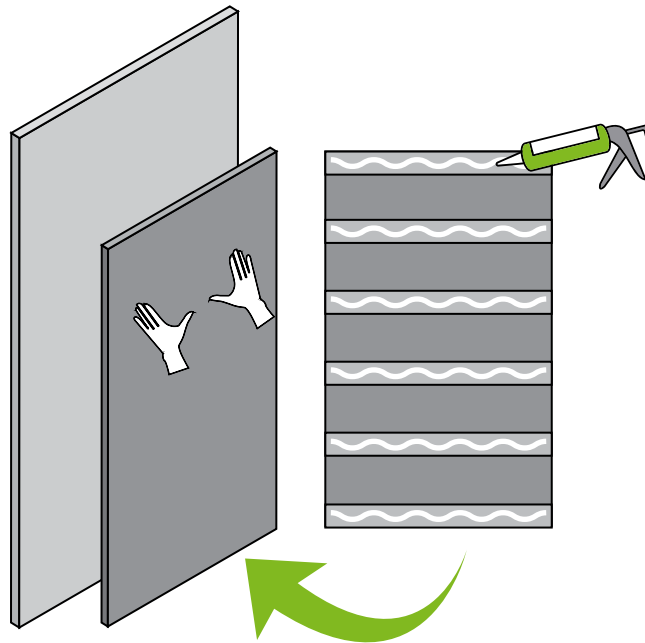

# FIBERGLASS MOUNT INSTALLATION

Fiberglass boards may be used to provide additional sound absorption behind PET panels. Owens Corning® Type 705 700 Series® Fiberglass Insulation™ Board is the suggested fiberglass option for this installation. PET panels can be direct fixed with a commercial adhesive. It is the installer's responsibility to ensure the adhesive used is appropriate for the product and substrate it is being fixed to.

- 1** Clean and prepare surface per adhesive guidelines, then spread adhesive evenly on 1-2" fiberglass board (recommended width – depending on desired acoustic results).

- 2** Adhere fiberglass to wall surface per layout and maintain even pressure per adhesive manufacturer time and instructions.

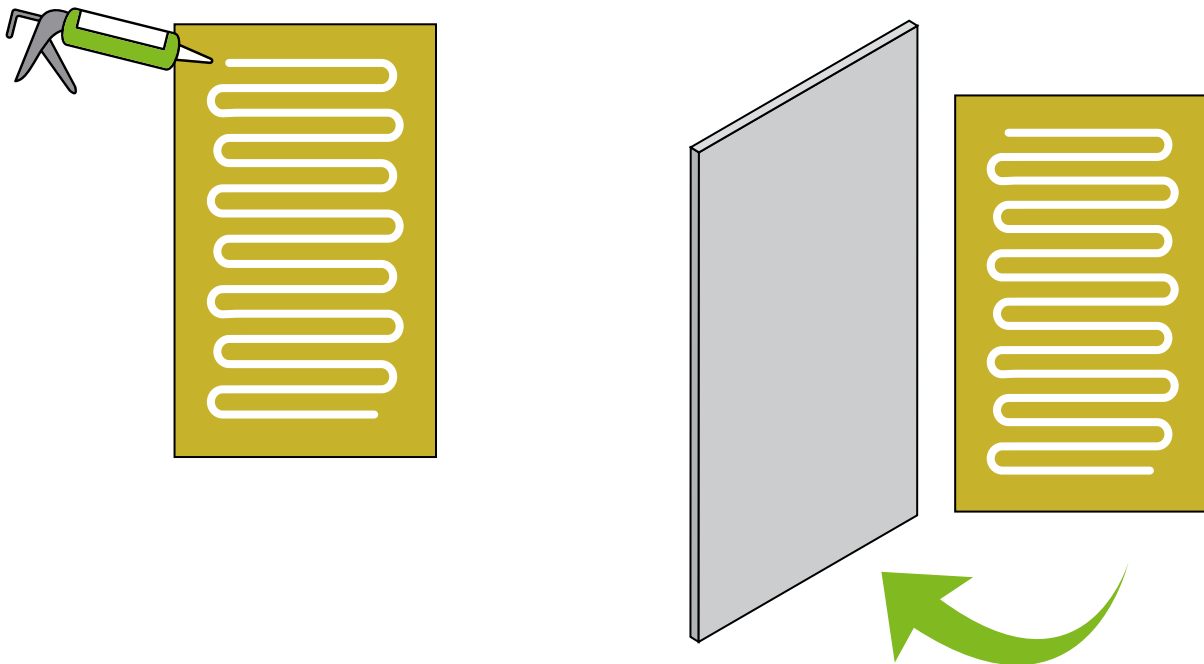

## FIBERGLASS MOUNT INSTALLATION

3

Spread adhesive on PET panels and adhere to fiberglass per layout. Brace per adhesive instructions and maintain even pressure per adhesive manufacturer time and instructions. Clean off any excess adhesive.

*Edges may be covered with additional panel strips or other surface for a clean edge.*

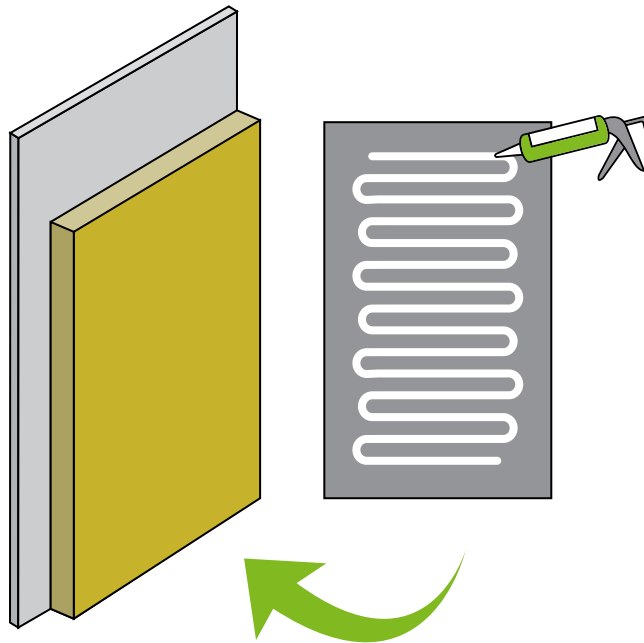

# TEMPORARY MOUNTING INSTALLATION

Hook and loop (i.e., Velcro®) tapes or double sided tapes (with acrylic adhesive) - of commercial grade - may be used for temporary mounting installation. The quality and durability of any temporary install is dependent upon the surface condition and texture of the substrate as well as the proper application of the mounting adhesive. The visual guidelines provide a baseline for a typical flat, smooth, wall in suitable and clean condition. Please note, PET panels may be damaged when removing from wall, depending on the amount and type of temporary adhesive used.

1

Clean and prepare surface per adhesive guidelines. Peel off one side of temporary adhesive and apply even pressure on panel. It is recommended to cover the panel with at least 30% coverage for best results.

2

Peel other side of the adhesive and adhere panel to a clean, flat surface per layout. Maintain even pressure per adhesive manufacturer time and instructions.

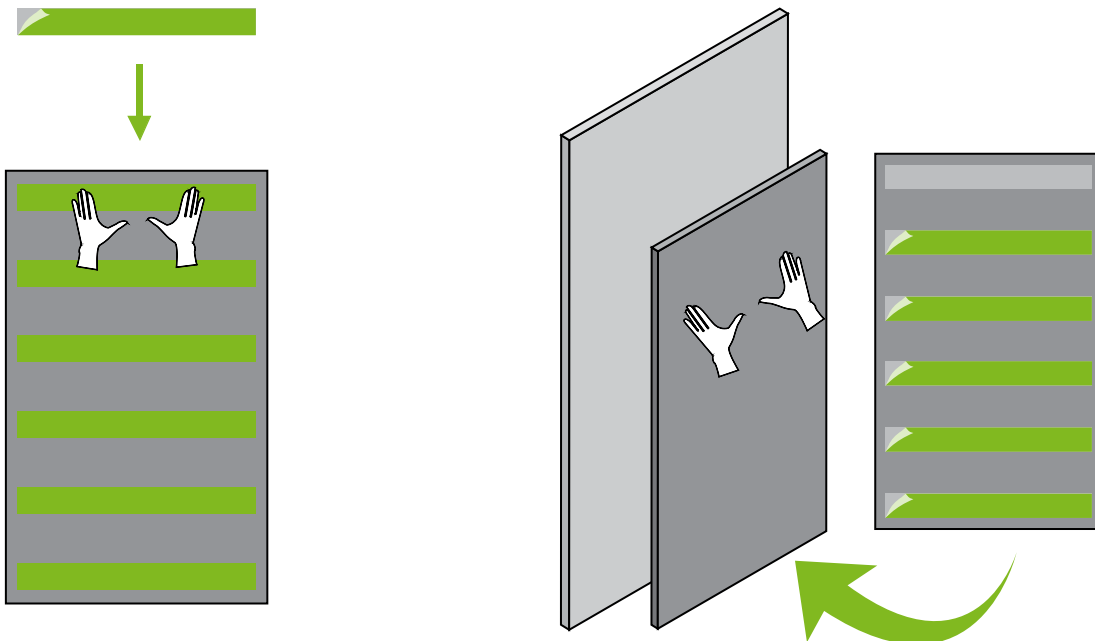

# Z-CLIPS INSTALLATION

Z-Clips may be used with PET panels by screwing Z-Clips into wall surface and into PET panels. Use screws that will not extend past panel surface.

1

Clean and prepare surface. Mount Z-Clips evenly spaced vertically on panel and wall. Place Z-clips 4"-6" from the top of the panel and wall, with multiple Z-Clips spaced regularly as needed to support the panel against potential impact. Full width Z-Clips are recommended for installing PET panels with Z-Clips.

To ensure panels lay flat, support panel weight from top full width Z-Clip. It is recommended that middle and bottom Z-Clips be installed with a 1/16" gap to allow for panel flex.

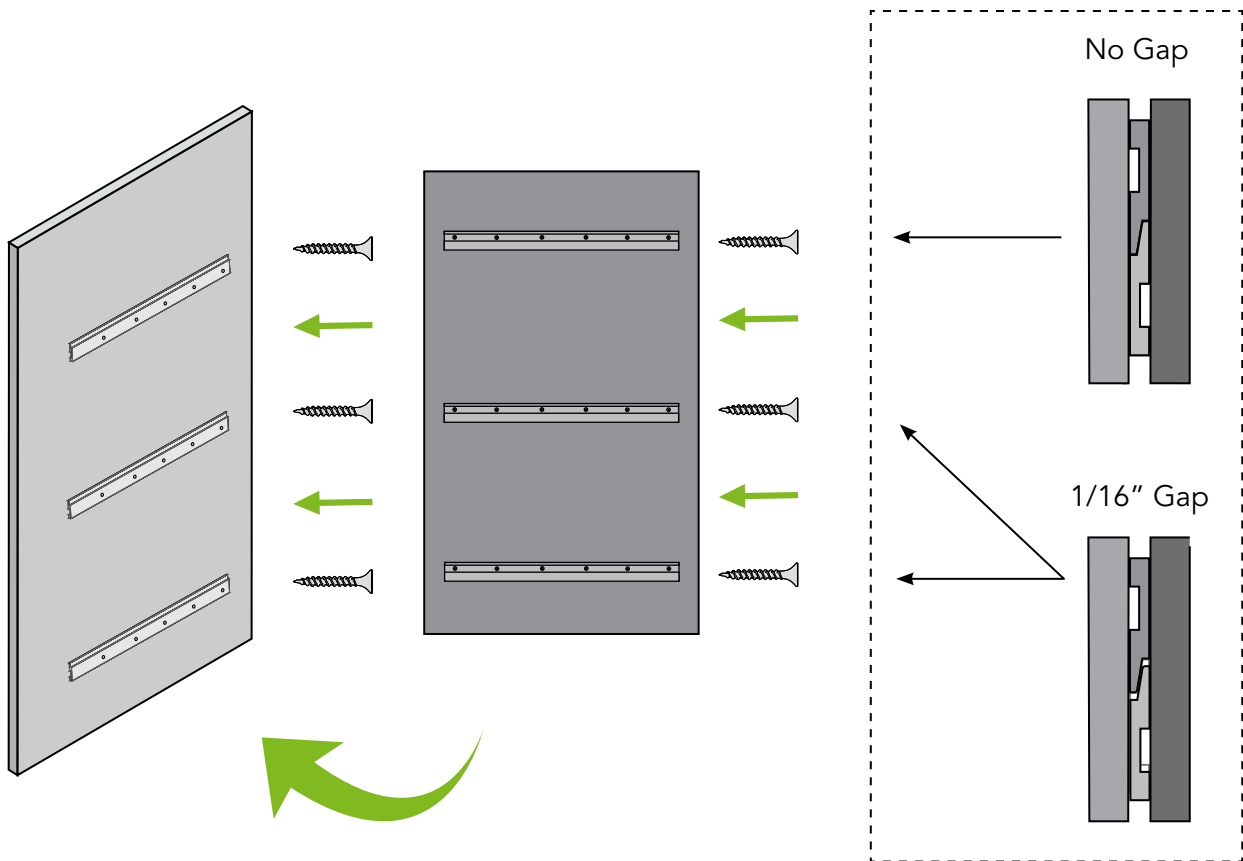

# MECHANICAL FASTENERS INSTALLATION

PET panels can be fastened to surfaces using mechanical fasteners such as nails, screws or staples where appropriate. Ensure proper fasteners to match substrate are used. The benefit of using mechanical attachments is that they can be removed completely without leaving residue in order to allow the panels to be recycled fully. Don't over tighten fasteners to avoid denting or pillowing the panel surface and don't use self-tapping screws to hang large panels. Nails or screws should be fastened into battens or suitable substrates.

**1**

Clean and prepare surface. Drill holes minimum 15mm center offset from each corner and slightly oversized to allow for thermal expansion and contraction. Insure drilled holes have smooth edges.

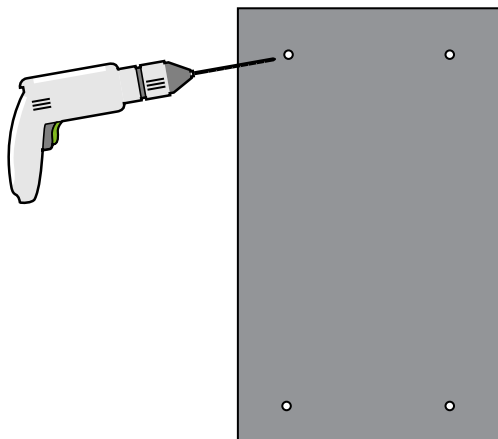

**2**

Fasten panel to wall surface per layout. Use washers for better load distribution and to prevent pull-through. Also, use metal inserts if frequent assembly/ reassembly is required.

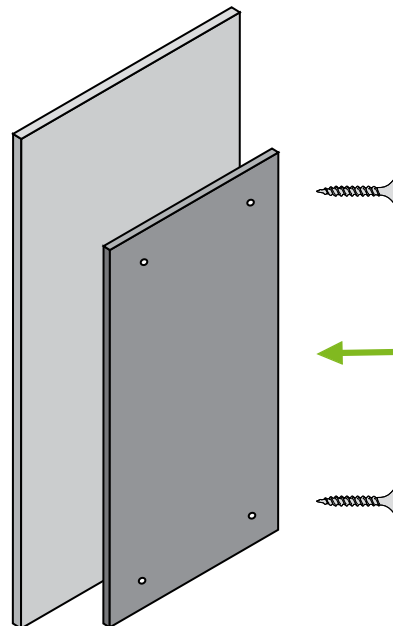



# FRAMING SYSTEM INSTALLATION

PET panels are commonly installed using a wide range of architectural aluminum trims. PET panels can be mounted to walls or used as a freestanding panel by using aluminum or other metal or plastic extrusions such as T, J, H or L trim strips as frames. These are ideal for using with PET panels as they create lightweight, easily assembled systems that avoid the use of non-recyclable glues and tapes.



Clean and prepare surface per adhesive guidelines, then follow manufacturers directions for installation. PET panels may be framed with standard J-molding or other trim molding as per molding instructions. Please note metric sizing of PET panels (12mm or 24mm) when selecting moldings/trim.

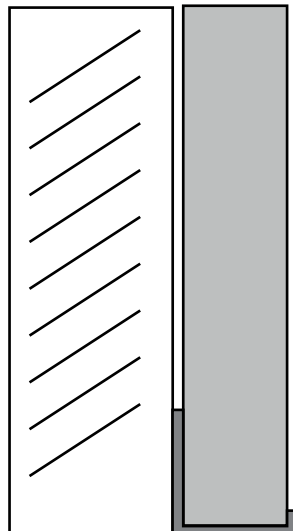

# kirei

## CONTACT INFORMATION

Phone: 619.236.9924

Email: [info@kireiusa.com](mailto:info@kireiusa.com)

Web: [kireiusa.com](http://kireiusa.com)

---

### Our Mission

Kirei strives to inspire a beautiful world by providing architects, interior designers, and placemakers with sustainable architectural design elements for inspiring healthy spaces.

### Committed To Sustainability

Kirei prioritizes sustainable design in our materials and our process. Our products must contain a minimum of 50% or more recycled material, meet or exceed CDPH standards for VOCs, and must be Red List Free and Declare Label qualified/certified. From tiles made of plastic bottles to baffles filled with Nike Grind, being "green" is a key quality of all our products.

### Our Proven Process

Our proven process is simple and guides all that we do. We listen and learn the needs of a designer's project to inspire and assist through the specification process. We get the spec right, working with installers and contractors to get accurate bid information. We provide best-in-class service that includes reliable delivery and installer support, ensuring that each project gets exactly what it needs when it needs it. Finally, we celebrate the designer, their project, and the win!