

AIR BAFFLE

INSTALLATION GUIDE

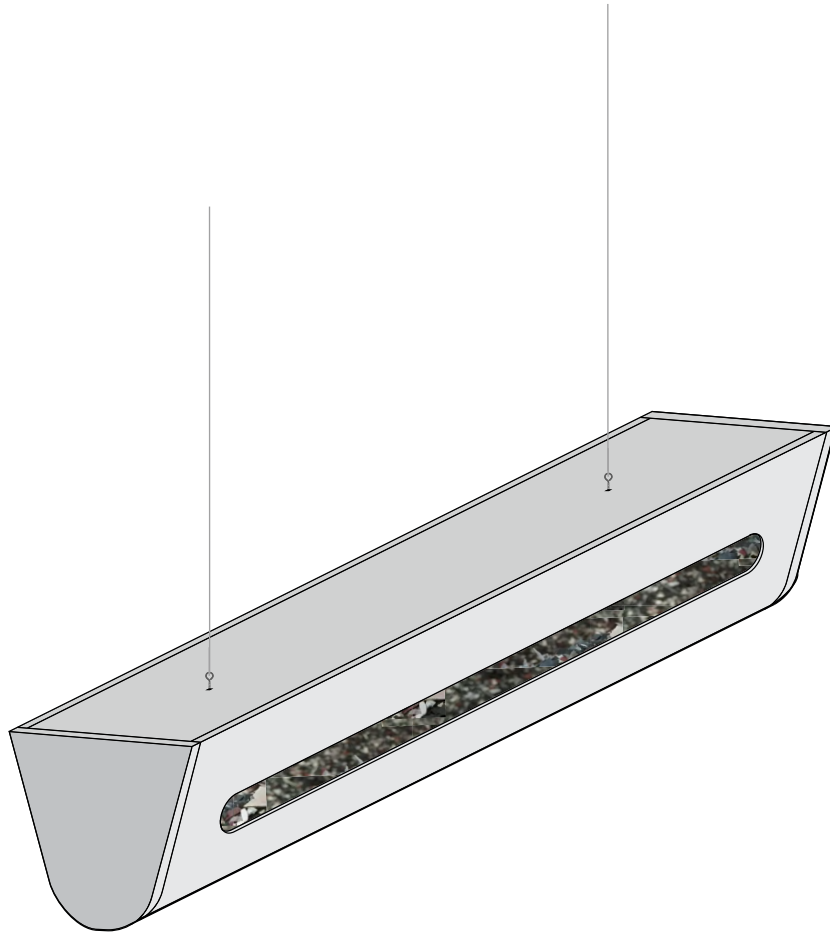

kirei

IMPORTANT INFORMATION

Installation

Please read the entire Installation Guide prior to application. This installation guide is intended to provide installers with helpful information regarding Air Baffle prior to installation. Kirei accepts no responsibility for installation actions taken or not taken. This installation guide is not intended to be an in-depth guide; installer's knowledge as an experienced tradesman needs to be applied.

If you have questions about application or techniques, contact Kirei. Kirei will not be responsible for any cutting or mounting not performed by Kirei staff.

Terms of Trade

All Air Baffle products are inspected prior to shipment. Kirei is not responsible for damage in shipment or in storage; customers should carefully inspect all items at time of delivery and note any obvious damage on the delivery receipt. For the customer's protection subsequently discovered concealed damage must be reported immediately to the carrier. Claims to Kirei will not be considered if the sheet has been worked on by the customer or others. No claims for labor charges will be allowed in any circumstances.

Work Safety

In the interest of work safety, it is recommended that people working with Air Baffle wear the appropriate safety equipment. Although the product emits zero off-gases, masks and gloves should be worn to ensure the maximum possible safety precautions. For an SDS form, please contact Kirei.

Product Notes

Air Baffle's acoustic performance will alter based on a variety of factors including spacing between baffles. Air Baffles have a grain that can reflect light differently, looking slightly lighter or darker depending on placement.

Cleaning & Handling

Do not store Air Baffles vertically, please store laying flat.
See the [Handling and Cleaning Guide](#) for more information.

Air Baffle Specs

See the [Air Baffle Spec Sheet](#) for product details and information.

Product & Installation Questions

PH: 619.236.9924

Email: info@kireiusa.com

Web: kireiusa.com

HANDLING

Carry boxes and products upright.

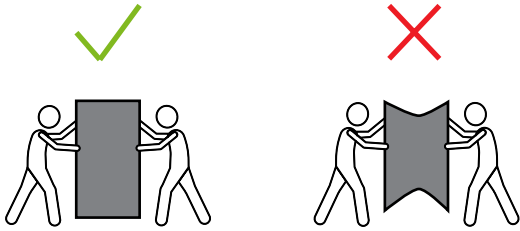

Keep all surfaces clean for storage and fabrication.

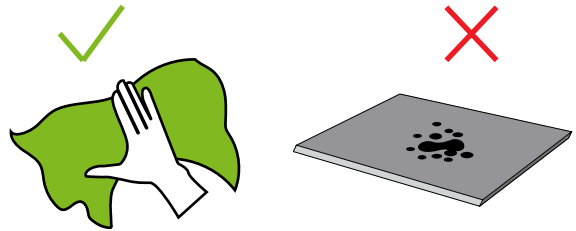

Store boxes and panels flat.

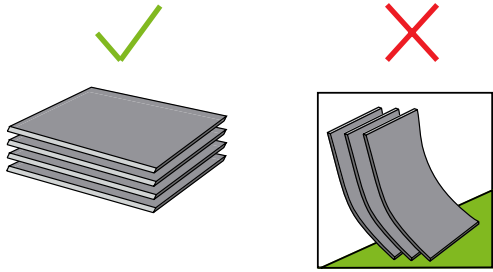

Store in a cool, dry place with no direct sun. Avoid 145 degree temperatures or greater.

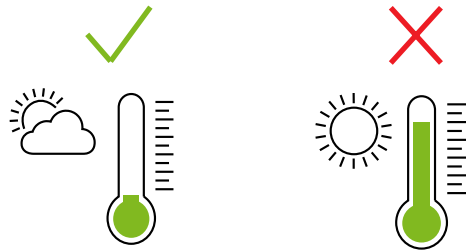

Wear gloves for handling light colors.

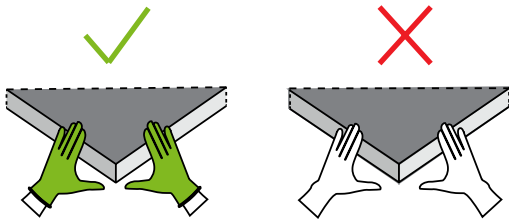

Upon delivery, inspect all goods for order corrections and damage.

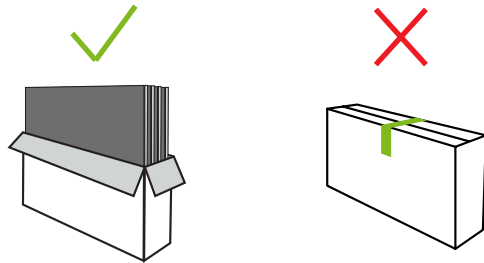

Keep product dry and avoid humidity.

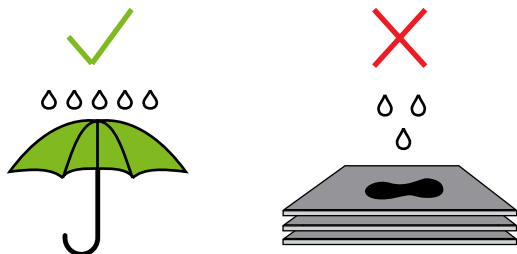

Protect the edges.

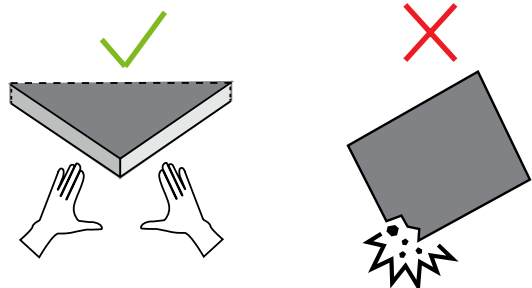

DIMENSIONS

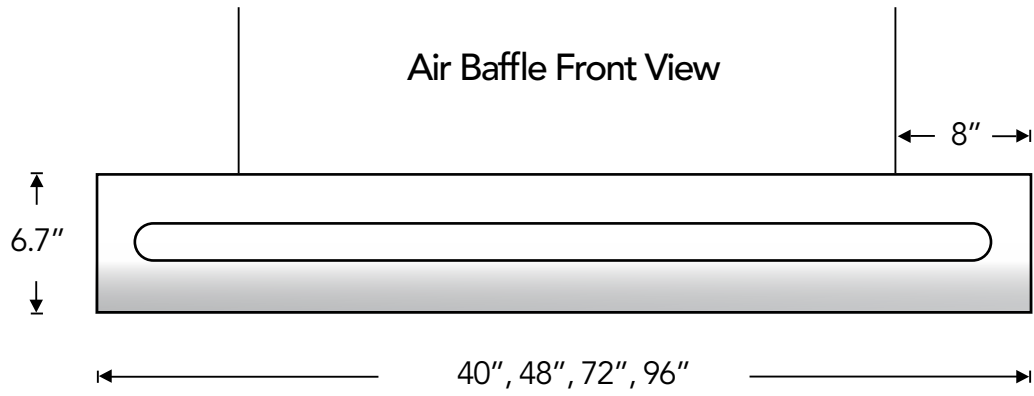

Air Baffle Side View

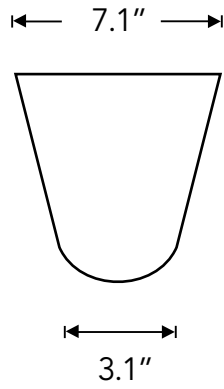

Air Baffle Short Window

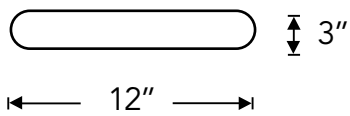

Air Baffle Long Window

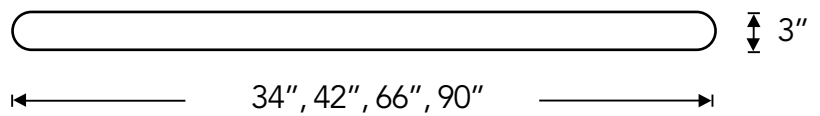

TOOLS NEEDED

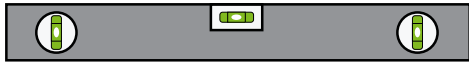

Level

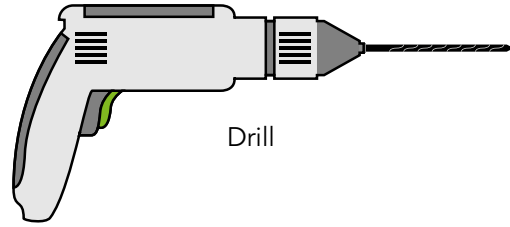

Drill



Crimper



Wire Cutter

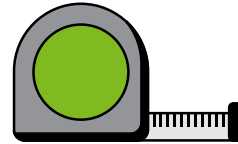

Tape Measure

Not all tools are needed for installation, but depending on install choice, could be used.

ITEMS INCLUDED

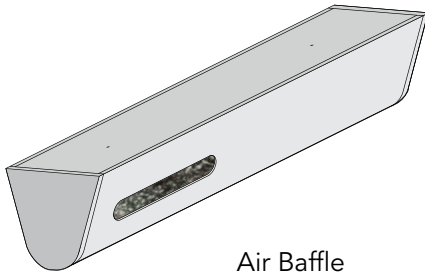

Air Baffle



1/4" - 20 Male Threaded Screw

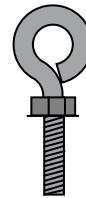

Eyebolt

Baffle Hardware - 2 per baffle
(eyebolt or threaded screw)

OPTIONAL (NON-INCLUDED) ITEMS

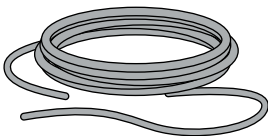

Aircraft Cable



Threaded Rod



Set screw Attachment



Eyebolt Attachment

These are optional items that could potentially be used depending on installation.

INSTALLATION

1

After removing the baffle from the box, clean any debris off the baffle.

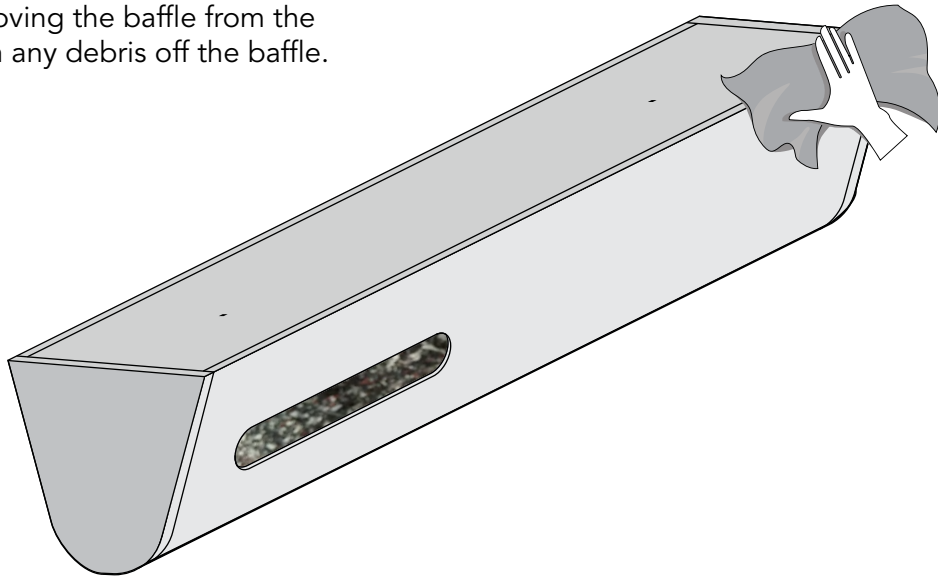

2

The fluff inside the baffle may become uneven during shipping. To level out the fluff, use two people to hold the baffle on each end, and gently shake.

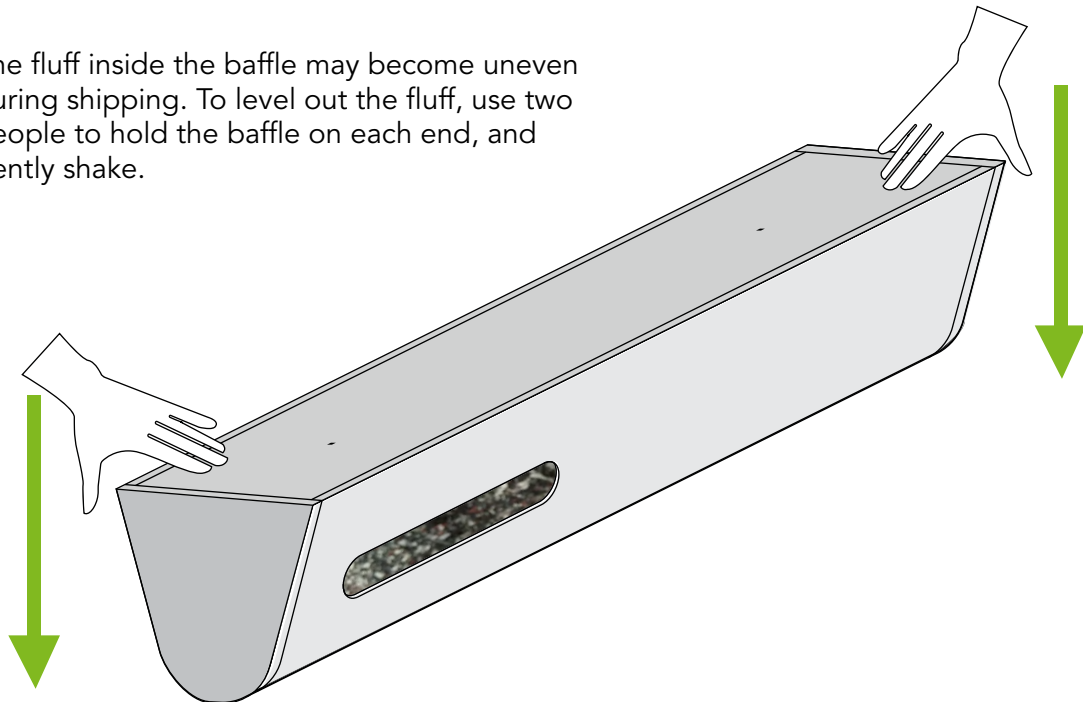

INSTALLATION

- 3** Each baffle has two attachment points and comes with baffle hardware of your choice - eyebolts or 1/4" - 20 male threaded screws.

Hardware is not attached. To attach, locate the box with the hardware and screw into the two female threaded attachment points in the baffle.

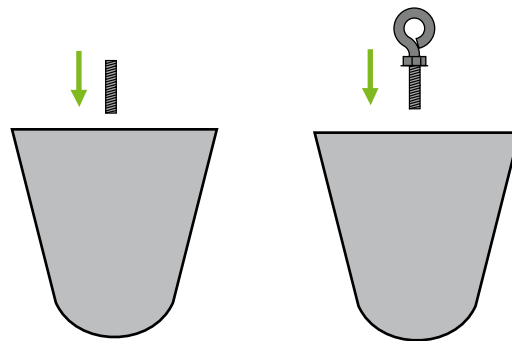

- 4** Add the suspension cable/chain/rod/etc to the baffle attachments, and then fasten appropriate baffle attachments to the baffle hardware. *Ceiling mounting hardware, suspension items, and baffle attachments are not included.*

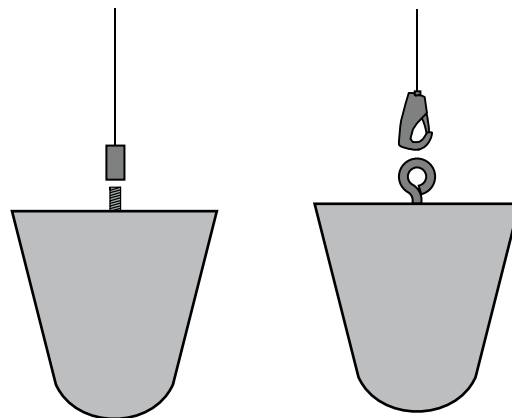

INSTALLATION

- 5 Securely mount the appropriate hardware to the ceiling and then, using a level to ensure accurate alignment, attach baffles to the hardware with the assembled suspension cable/chain/rod/etc.

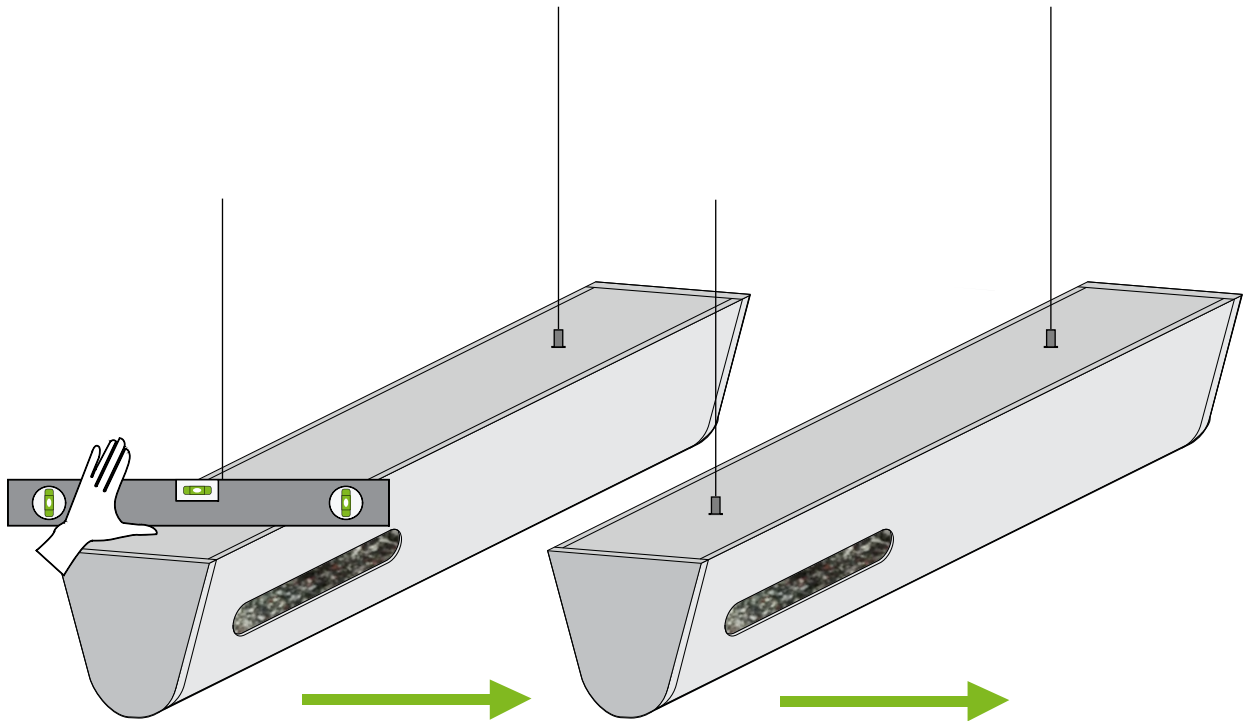

kirei

CONTACT INFORMATION

Phone: 619.236.9924

Email: info@kireiusa.com

Web: kireiusa.com

Our Mission

Kirei strives to inspire a beautiful world by providing architects, interior designers, and placemakers with sustainable architectural design elements for inspiring healthy spaces.

Committed To Sustainability

Kirei prioritizes sustainable design in our materials and our process. Our products must contain a minimum of 50% or more recycled material, meet or exceed CDPH standards for VOCs, and must be Red List Free and Declare Label qualified/certified. From tiles made of plastic bottles to baffles filled with Nike Grind, being "green" is a key quality of all our products.

Our Proven Process

Our proven process is simple and guides all that we do. We listen and learn the needs of a designer's project to inspire and assist through the specification process. We get the spec right, working with installers and contractors to get accurate bid information. We provide best-in-class service that includes reliable delivery and installer support, ensuring that each project gets exactly what it needs when it needs it. Finally, we celebrate the designer, their project, and the win!