

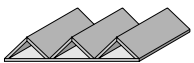

k

EchoRidge

VISUAL MOTION & ACOUSTIC CONTROL



EchoRidge Mini

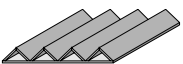

EchoRidge Micro

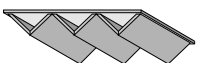

EchoFold Mini ACT

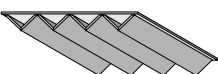

EchoFold Micro ACT

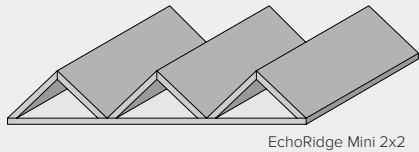

EchoRidge Mini 2x2

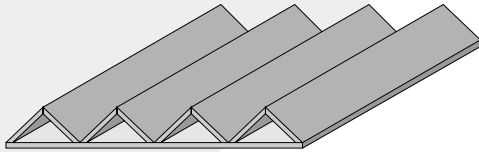

EchoRidge Micro 2x2



EchoRidge Micro 2x4 | Color 402

	Metric Length x Folded Width	Standard Length x Folded Width	Installed Height	Thickness	Weight	SF/Unit
Mini 2x2	584mm x 584mm	23 in. x 23 in.	114mm (4.5 in.)	12mm	5 lbs	3.7
Mini 2x4	584mm x 1168mm	23 in. x 46 in.	114mm (4.5 in.)	12mm	10 lbs	7.35
Micro 2x2	584mm x 584mm	23 in. x 23 in.	89mm (3.5 in.)	12mm	5 lbs	3.7
Micro 2x4	584mm x 1168mm	23 in. x 46 in.	89mm (3.5 in.)	12mm	10 lbs	7.35

All specs refer to singular products and not multiples unless specified. Due to the nature of the material, cutting and fabrication process, minor dimensional variances may occur. Custom options available upon request. EchoRidge is sold individually, and is folded and assembled prior to shipping for simple adhesive installation.

EchoRidge

Navigate acoustic obstacles with EchoPanel® EchoRidge, the unique dual-layer wall and ceiling tile that helps capture and absorb unwanted sound. EchoRidge comes in two styles - mini and micro - in both 2x2 and 2x4 tile sizes. Available in 27 colors, EchoRidge is a dynamic design element for any environment. Have a unique design idea? Customization is also available.

NRC (SOUND ABSORPTION RATING): ASTM C423-90A

Standard EchoPanel® NRC acoustic data is available for acoustic calculations. Please contact Kirei for this test data.

Fire Rating

ASTM E84 Class C (Class A treatment available.)

VOC Emissions

CDPH (CA 01350) Compliant; TVOC: <0.5 mg/m3
Ecospecifier GreenTag Compliant; TVOC: 0.015 mg/m2/hr (ASTM D5116)



EchoRidge Mini 2x2 | Color 442



ECHOPANEL SYSTEMS: ECHORIDGE

Available EchoRidge Designs

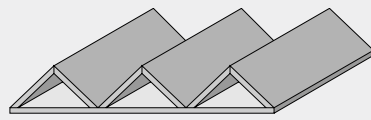

EchoRidge Mini 2x2

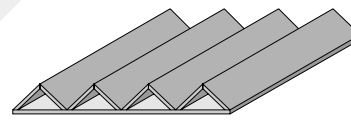
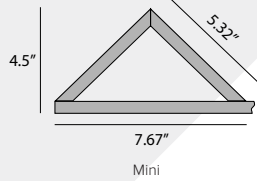

EchoRidge Micro 2x2

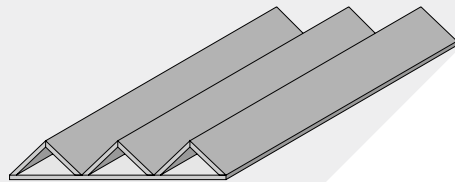
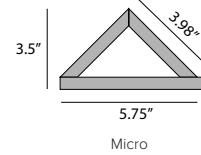

EchoRidge Mini 2x4

Note: EchoRidge is sold as an individual 3- or 4-peaked unit with a backer.

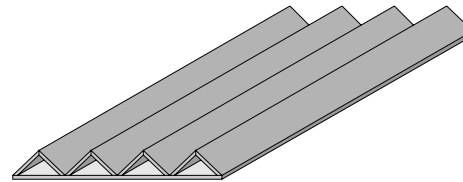

EchoRidge Micro 2x4

Available Solid Colors

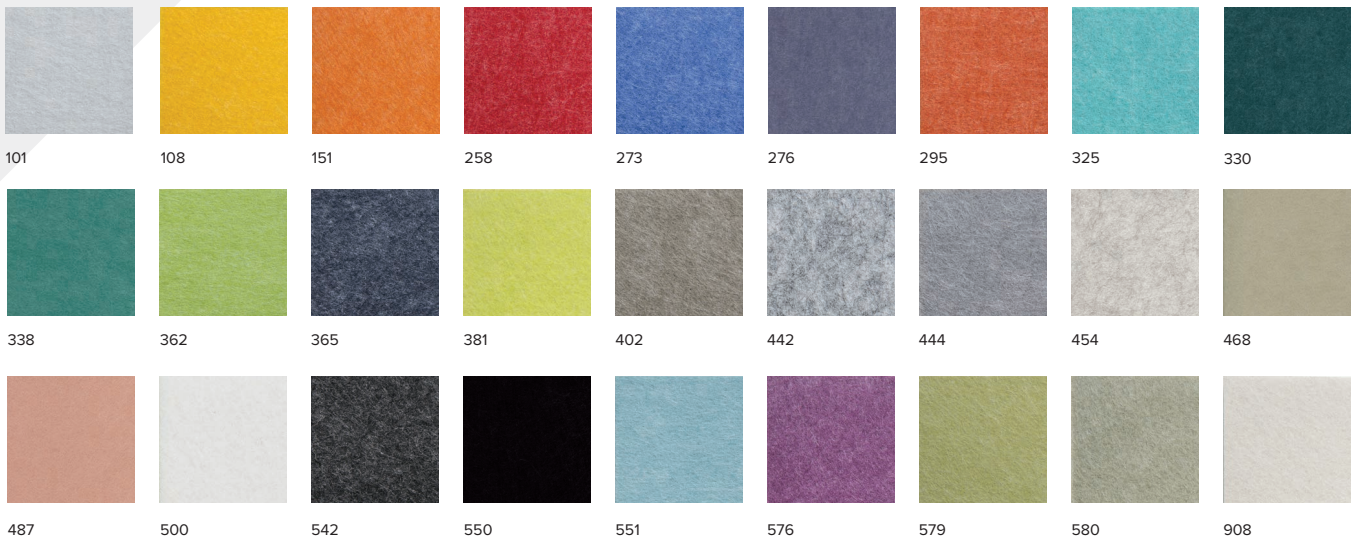

Installation



Mount

EchoRidge comes as an assembled unit on an EchoPanel backer. Install this product using standard construction adhesive (non-PVA). Visit www.kireiusa.com to download the EchoRidge Installation Guide.



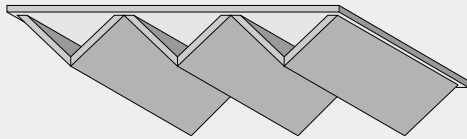

EchoRidge Mini ACT 2x2

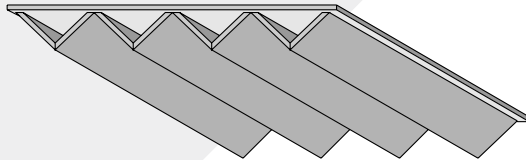

EchoRidge Micro ACT 2x2

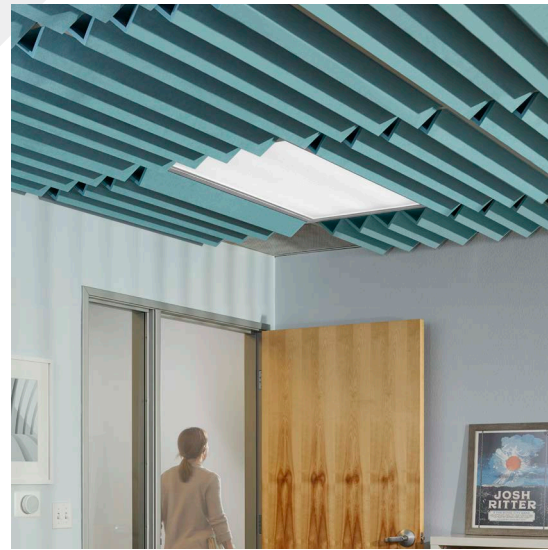

EchoRidge Micro ACT 2x2 and 2x4 | Color 551

	Metric Length x Folded Width	Standard Length x Folded Width	Exposed Height	Thickness	Weight	SF/Unit
Mini ACT 2x2	600mm x 600mm	23.6 in. x 23.6 in.	102mm (4 in.)	12mm	5 lbs	4
Mini ACT 2x4	600mm x 1200mm	23.6 in. x 47.2 in.	102mm (4 in.)	12mm	10 lbs	8
Micro ACT 2x2	600mm x 600mm	23.6 in. x 23.6 in.	76mm (3 in.)	12mm	5 lbs	4
Micro ACT 2x4	600mm x 1200mm	23.6 in. x 47.2 in.	76mm (3 in.)	12mm	10 lbs	8

All specs refer to singular products and not multiples unless specified. Due to the nature of the material, cutting and fabrication process, minor dimensional variances may occur. Custom options available upon request. EchoRidge ACT is sold individually, and is folded and assembled prior to shipping for simple drop-in installation

EchoRidge ACT

Create acoustic nirvana in any standard drop ceiling with the peaks and valleys of EchoRidge ACT. The unique modules easily install into an existing grid, adding both dimension and sound absorption. EchoRidge ACT comes in two styles - mini and micro - in both 2x2 and 2x4 tile sizes. Available in 27 colors, EchoRidge ACT provides design options for any decor from neutral to vibrant. Have a unique design idea? Customization is also available.

NRC (SOUND ABSORPTION RATING): ASTM C423-90A

Standard EchoPanel® NRC acoustic data is available for acoustic calculations. Please contact Kirei for this test data.

Fire Rating

ASTM E84 Class C (Class A treatment available.)

VOC Emissions

CDPH (CA 01350) Compliant; TVOC: <0.5 mg/m3
Ecospecifier GreenTag Compliant; TVOC: 0.015 mg/m2/hr (ASTM D5116)



EchoRidge Mini ACT 2x2 and 2x4 | Color 444



ECHOPANEL SYSTEMS: ECHORIDGE ACT

Available EchoRidge ACT Designs

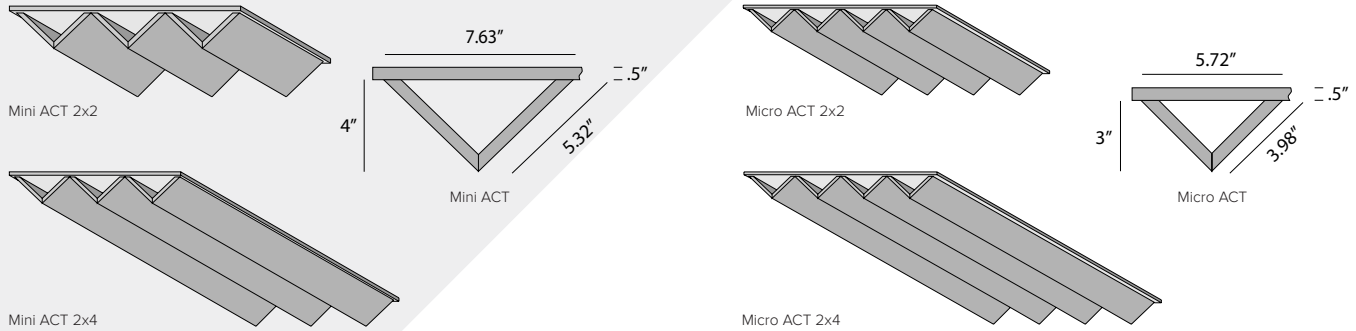

Note: EchoRidge ACT is sold as an individual 3- to 4-peak unit with an EchoPanel backer.

Available Solid Colors

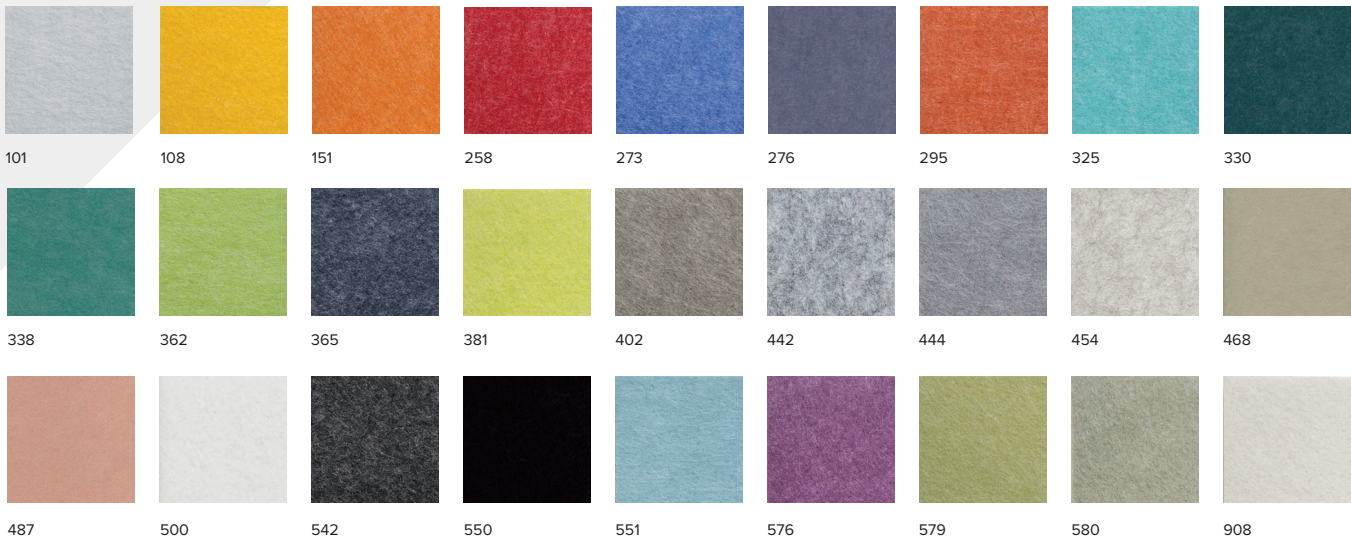

Installation

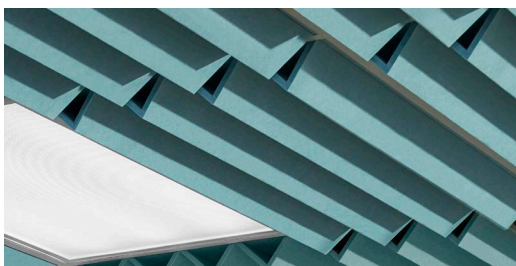

EchoRidge Micro ACT 2x4 | Color 551

Simple Drop-in

EchoRidge ACT tiles easily fit into a standard 15/16" ACT ceiling grid. Simply remove any existing ACT tile and install EchoRidge ACT in its place. Download the EchoRidge ACT Installation Guide for more information.

If you have a different ceiling grid, contact us for customization to match your needs.